

Isoline Sistemiyle **ARDUVAZ**

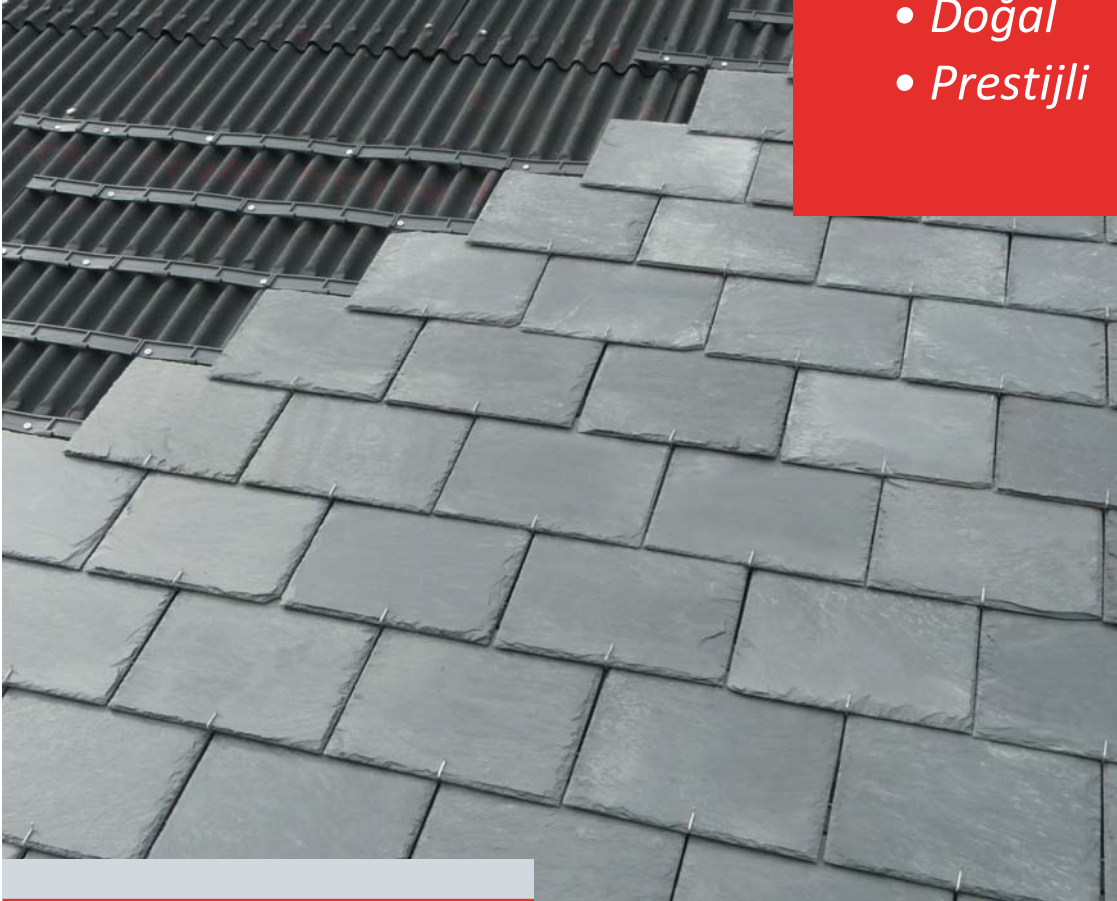

- *Uzun Ömürlü*
- *Estetik*
- *Doğal*
- *Prestijli*



Onduline[®]
AVRASYA A.Ş.

www.onduline.com.tr

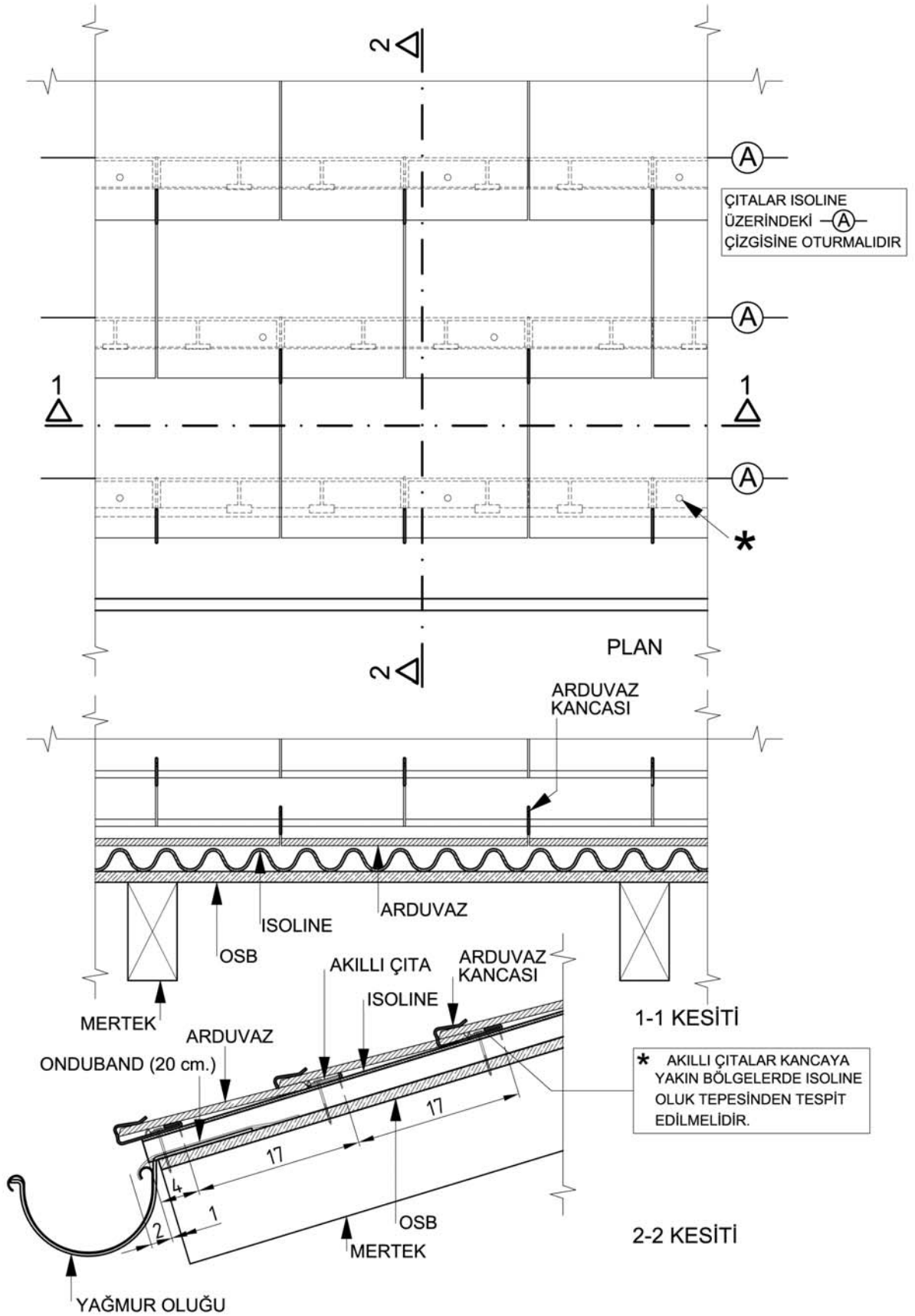

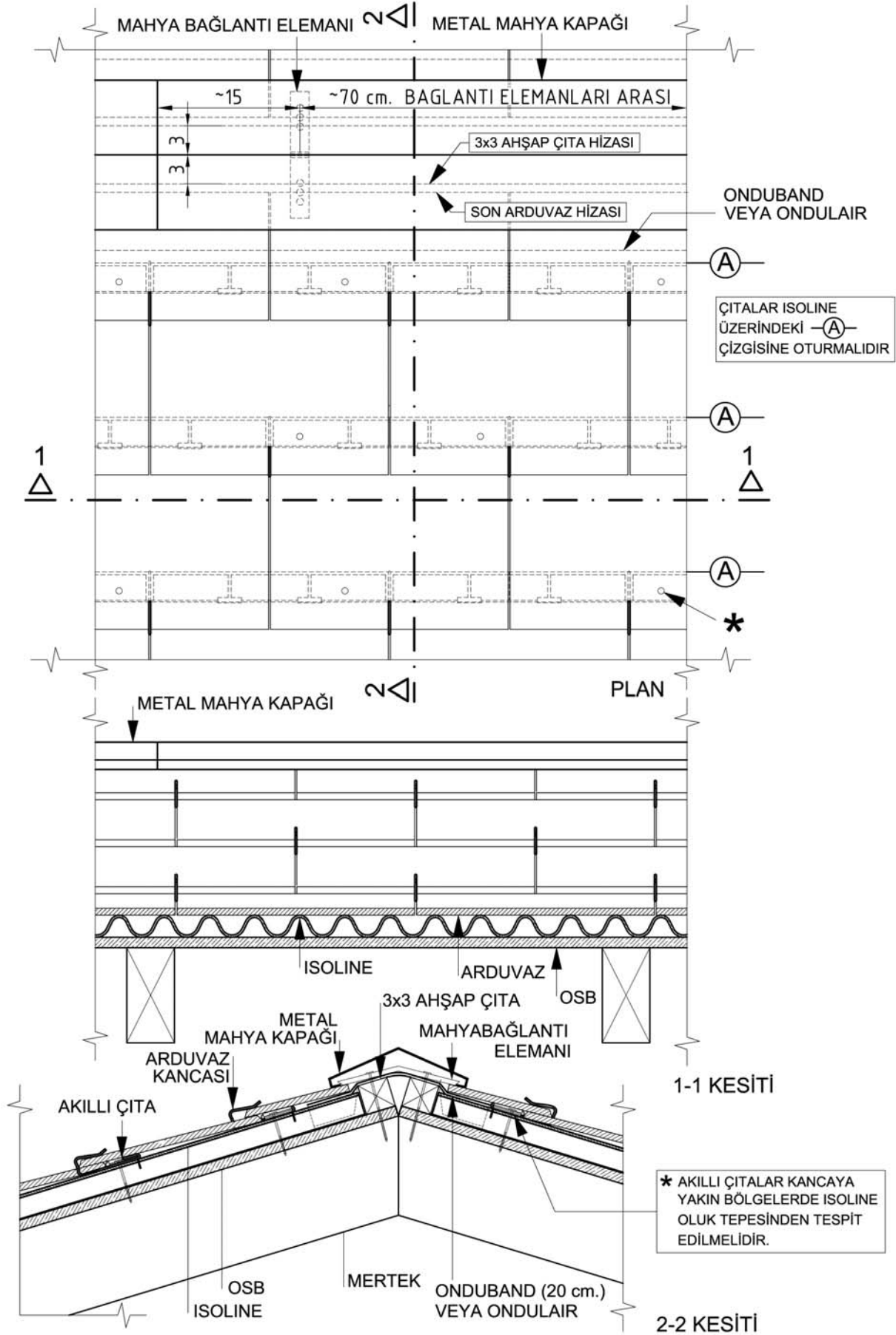

ÇİTALAR ISOLINE
ÜZERİNDEKİ —(A)—
ÇİZGİSİNE OTURMALIDIR

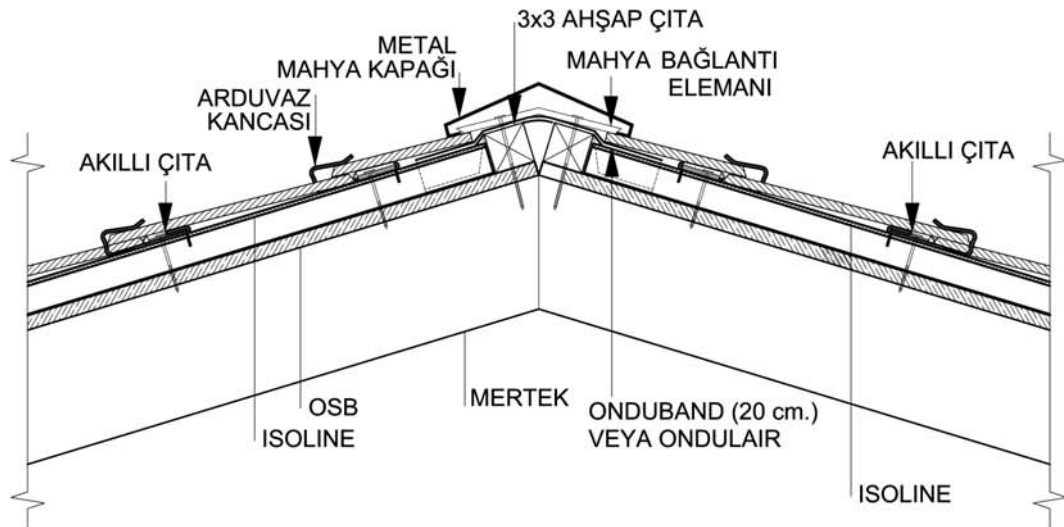
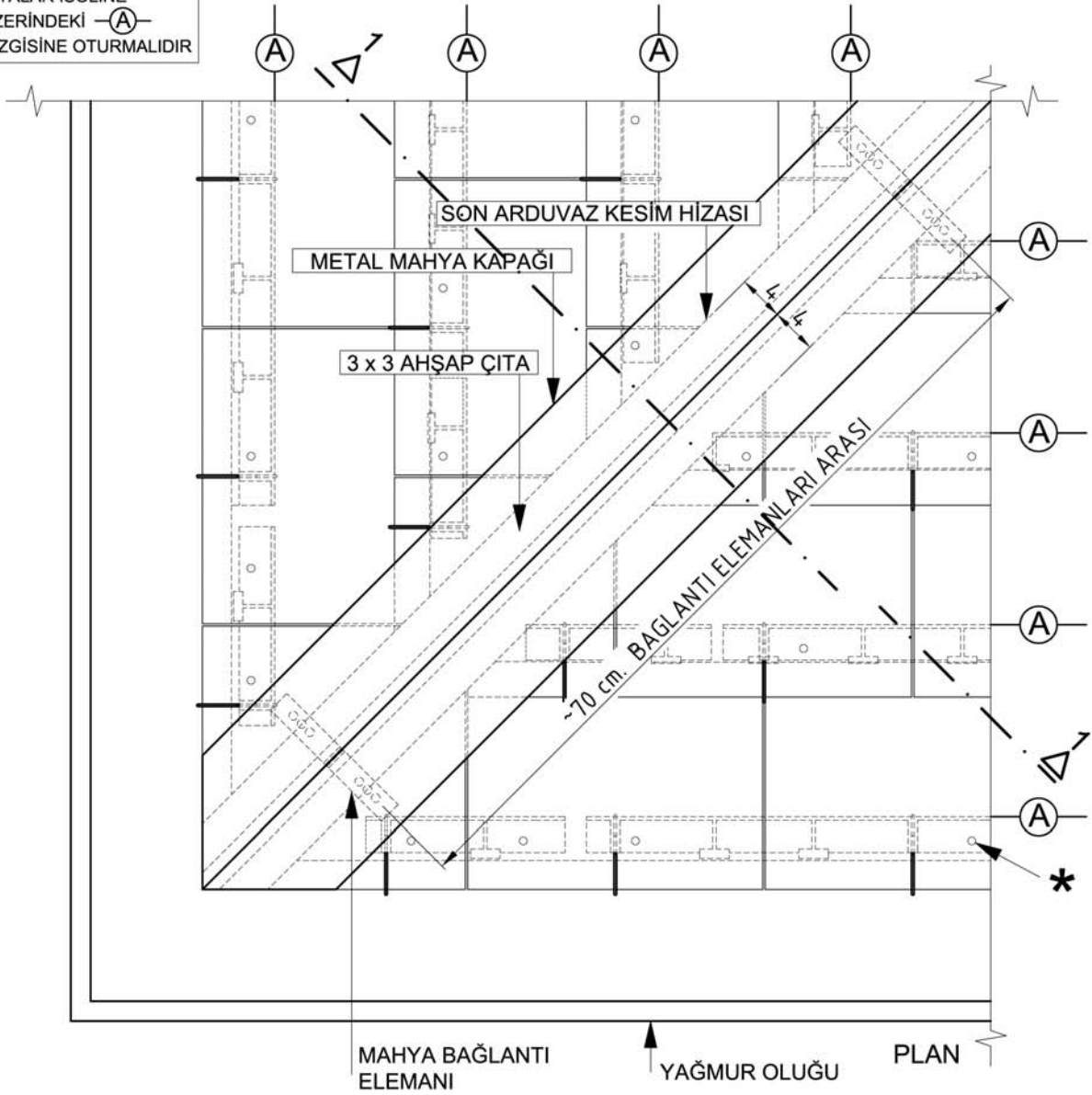

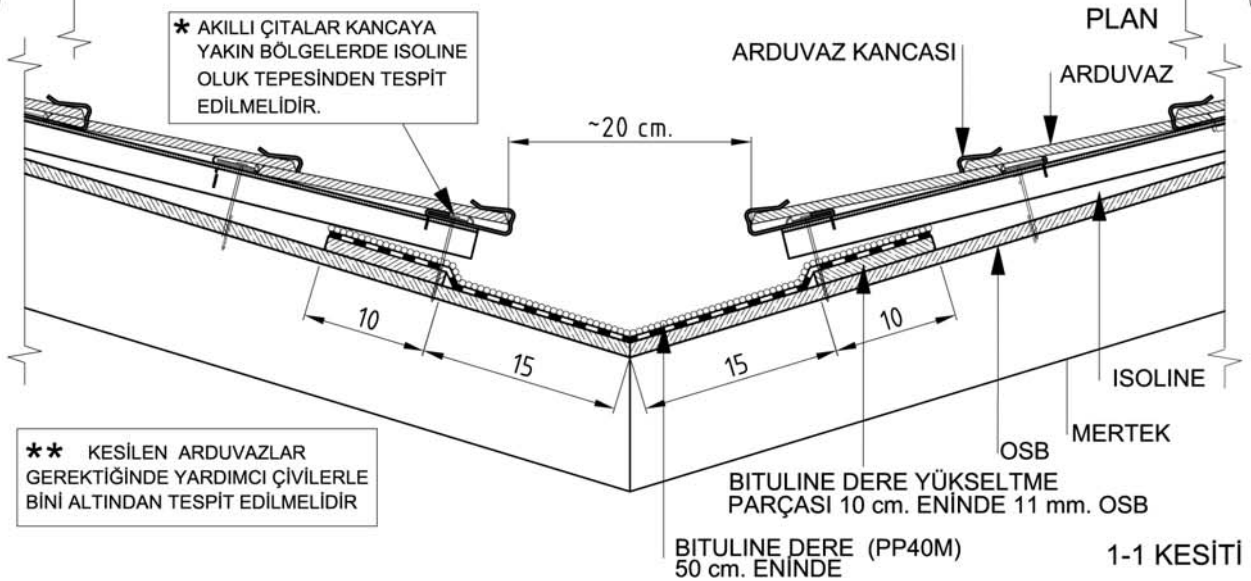
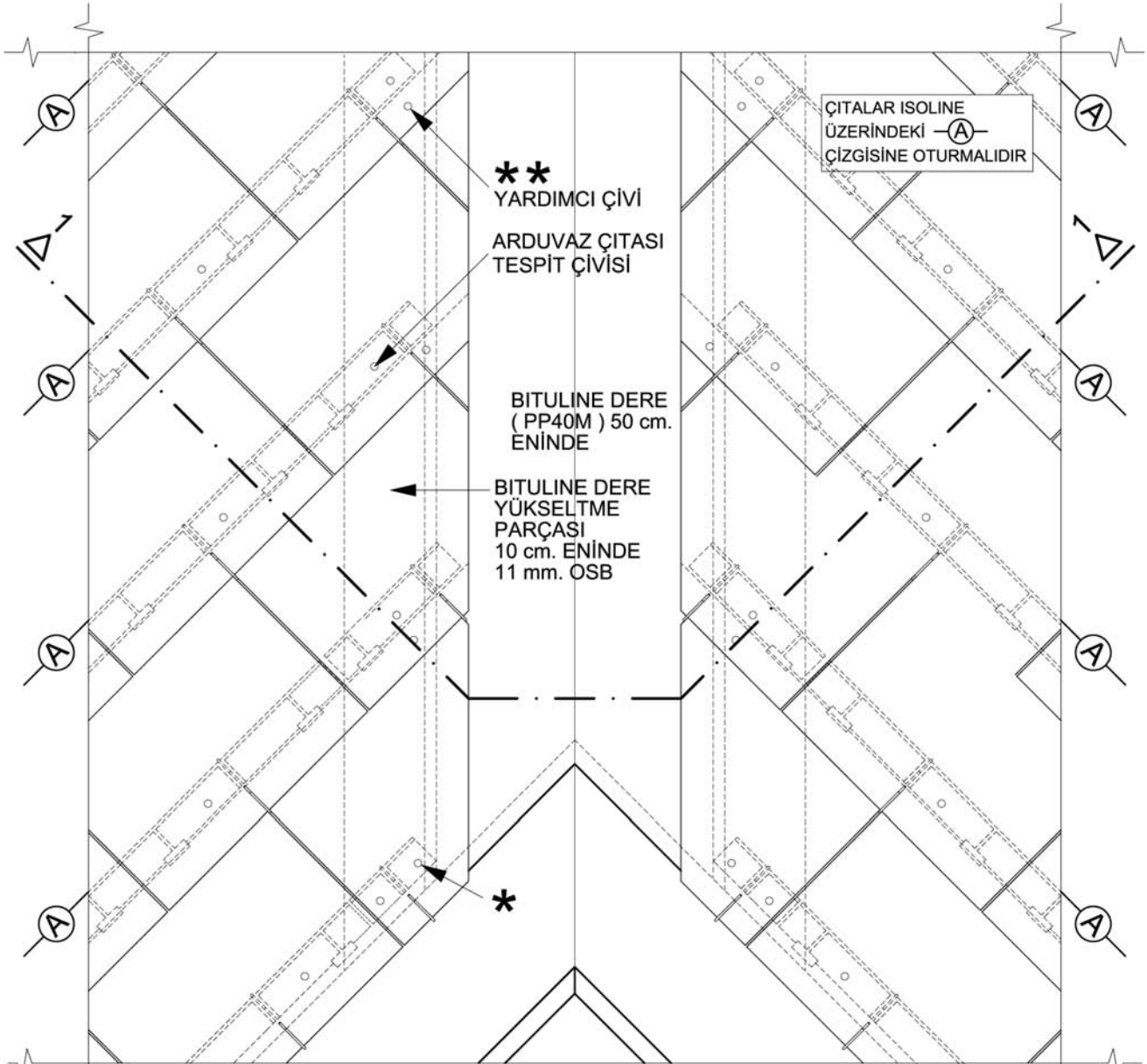

** KESİLEN ARDUVAZLAR
GEREKİĞİNDE YARDIMCI ÇİVİLERLE
BİNİ ALTINDAN TESPİT EDİLMELİDİR

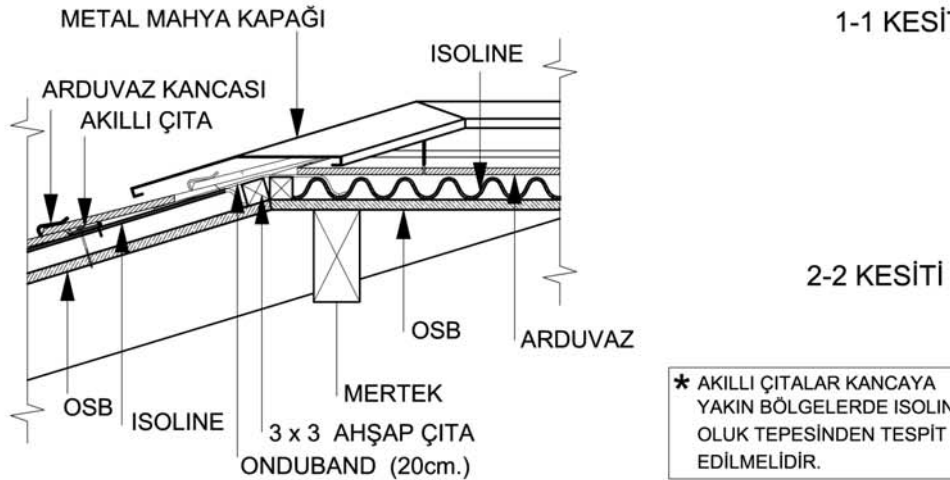
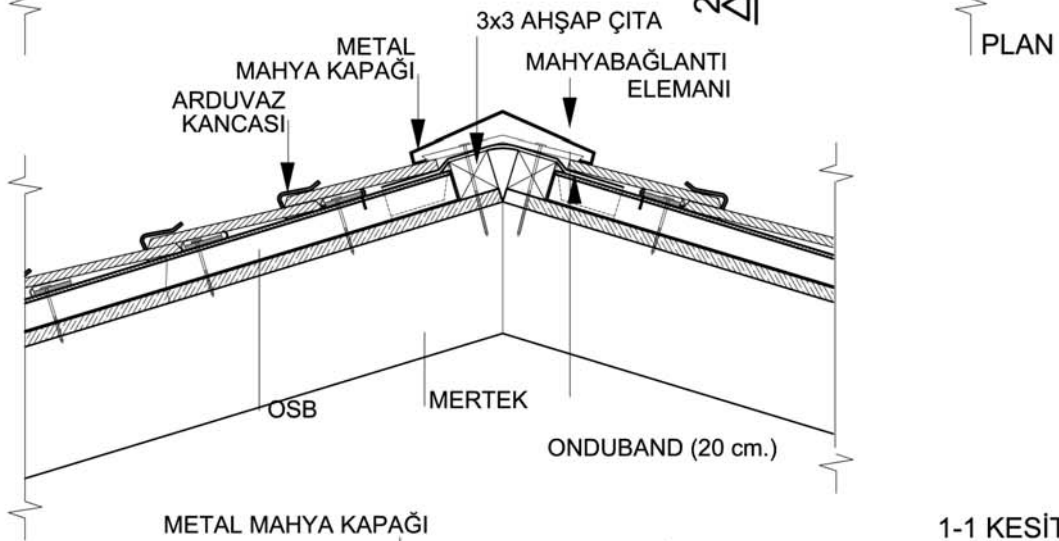
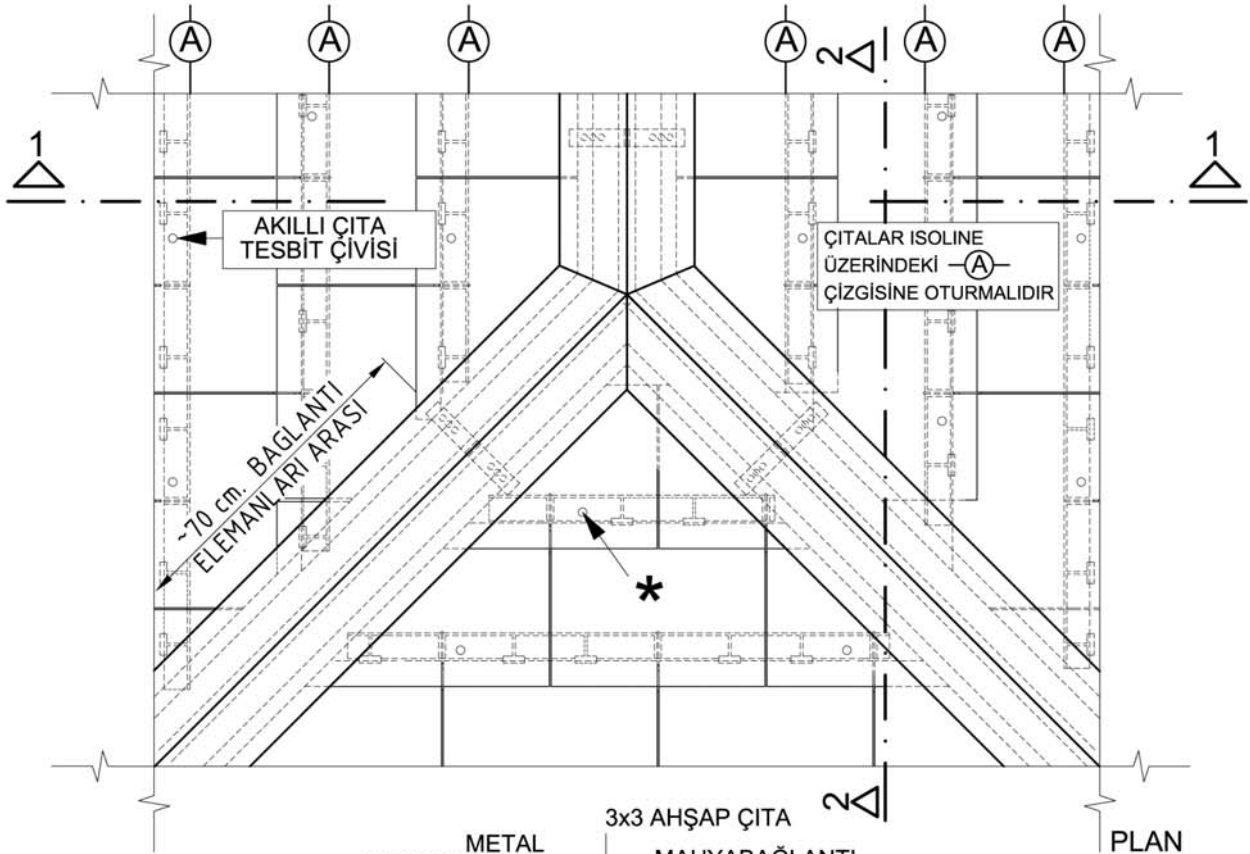

* AKILLI ÇİTALAR KANCAYA YAKIN BÖLGELERDE ISOLINE OLUK TEPEŚİNDEN TESPİT EDİLMELİDİR.

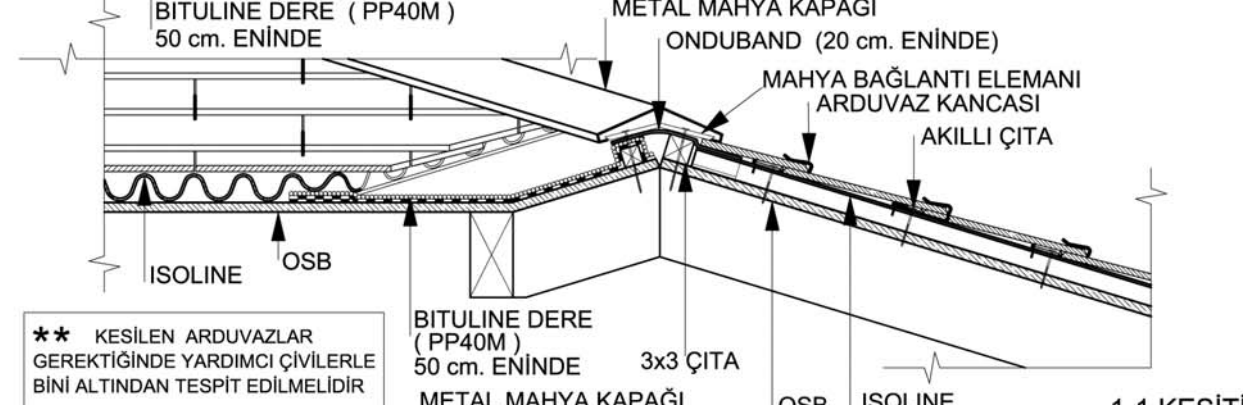
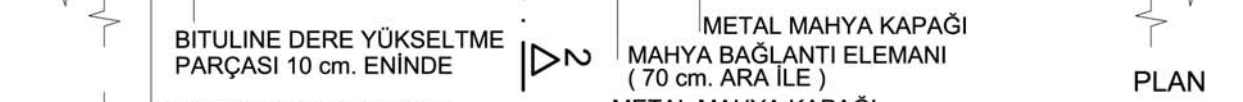
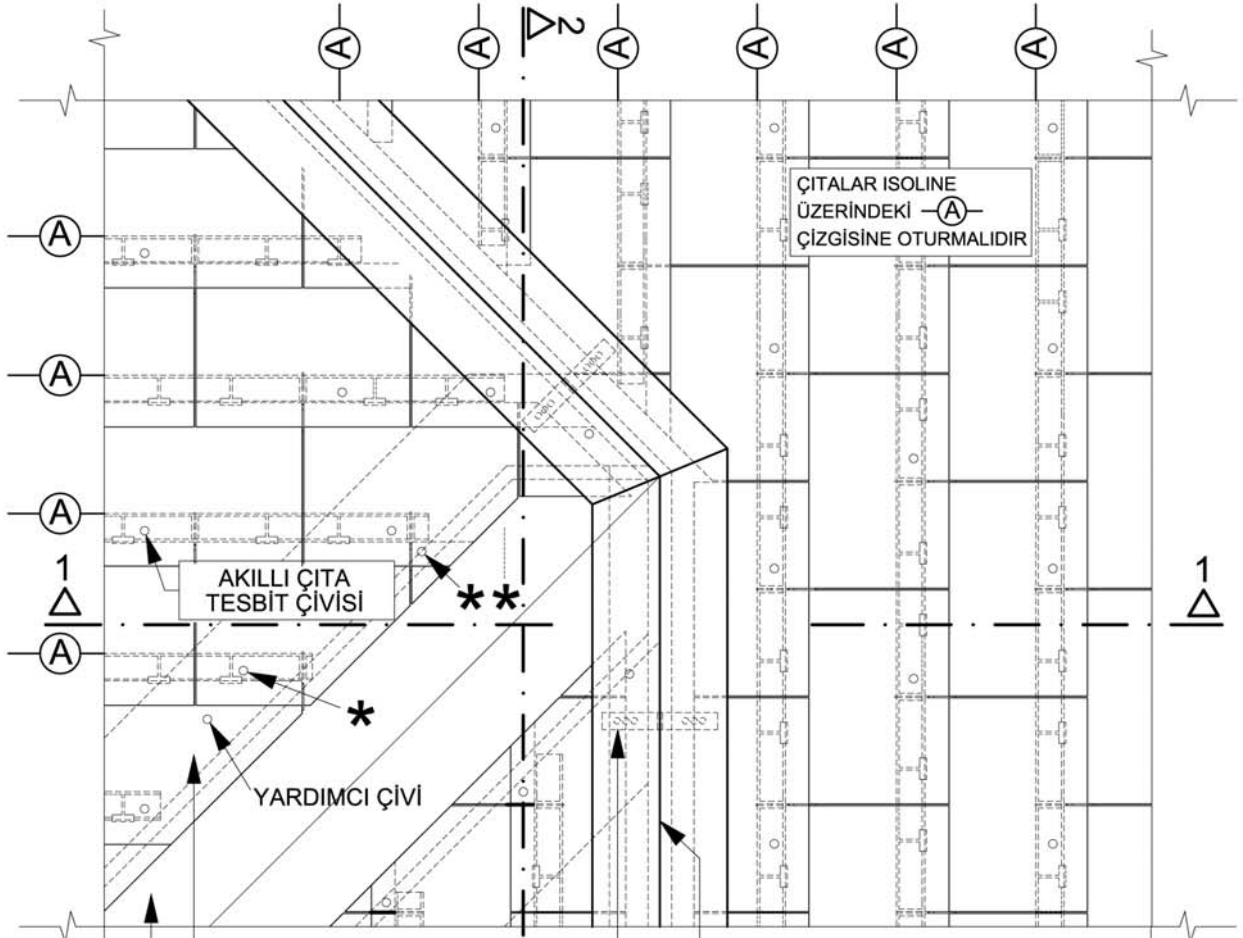

** KESİLEN ARDUVAZLAR GEREKTİĞİNDE YARDIMCI ÇİVİLERLE BİNİ ALTINDAN TESPİT EDİLMELİDİR



* AKILLI ÇİTALAR KANCAYA YAKIN BÖLGELERDE ISOLINE OLUK TEPEŚİNDEN TESPİT EDİLMELİDİR.

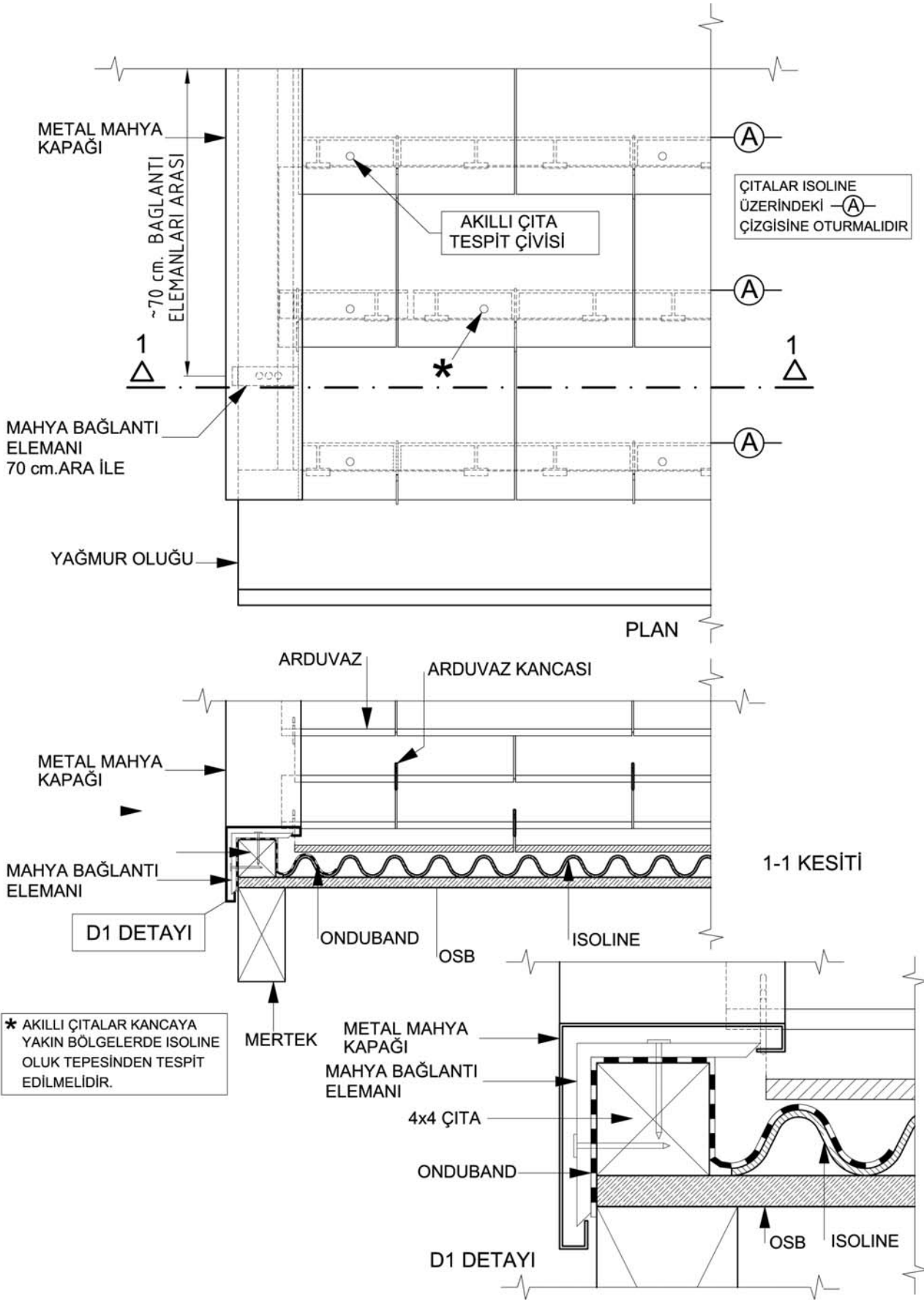

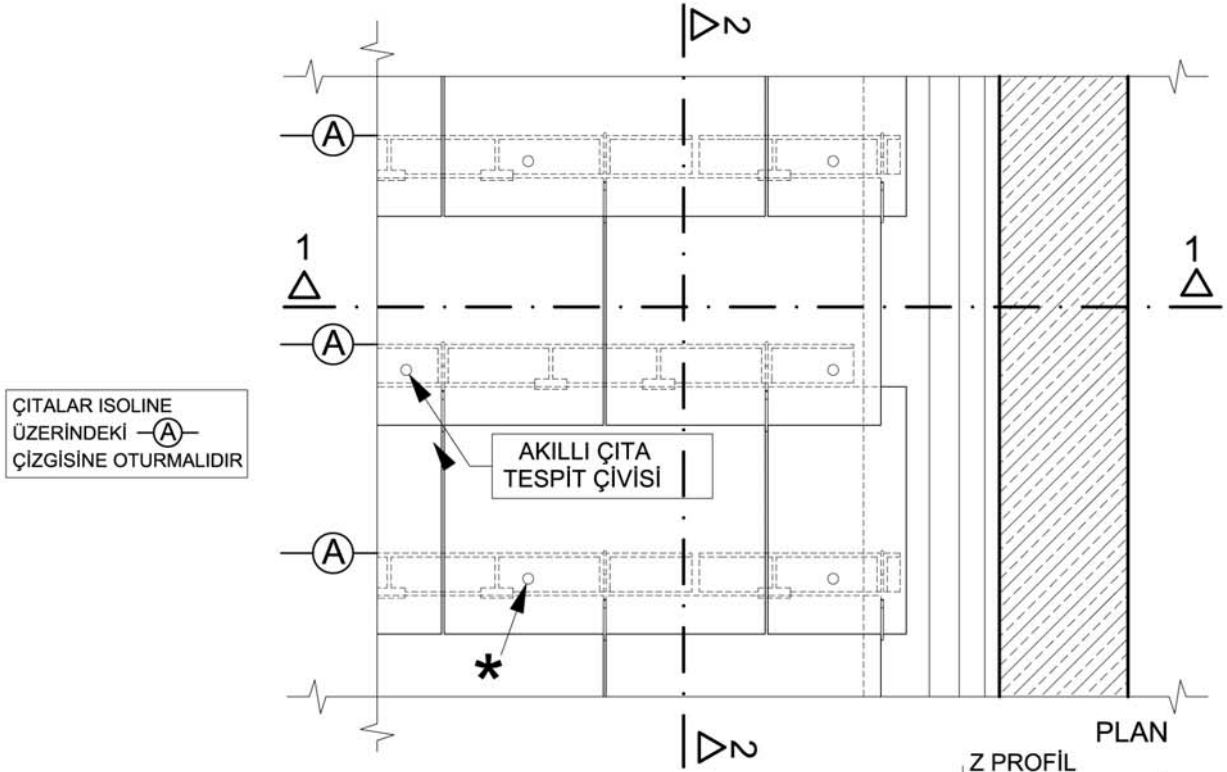

* AKILLI ÇİTALAR KANCAYA YAKIN BÖLGELERDE ISOLINE OLUK TEPEŚİNDEN TESPİT EDİLMELİDİR.

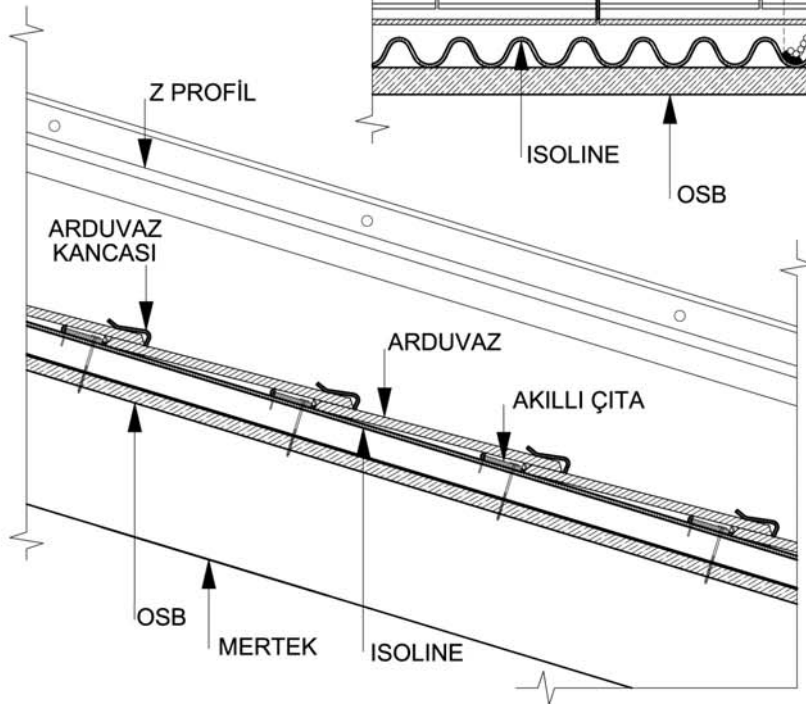
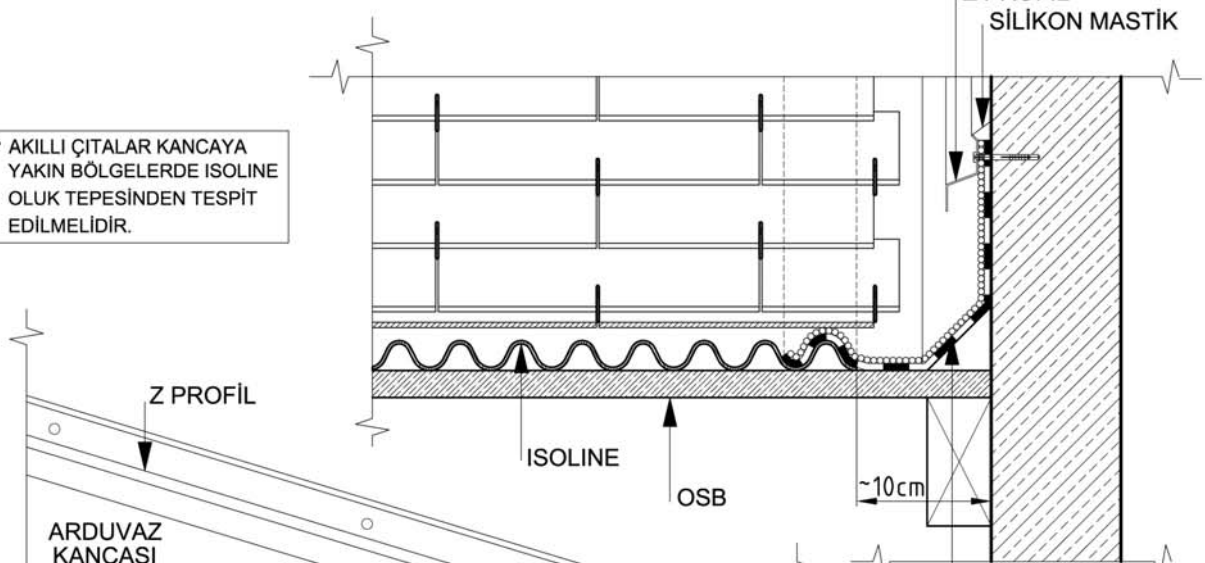

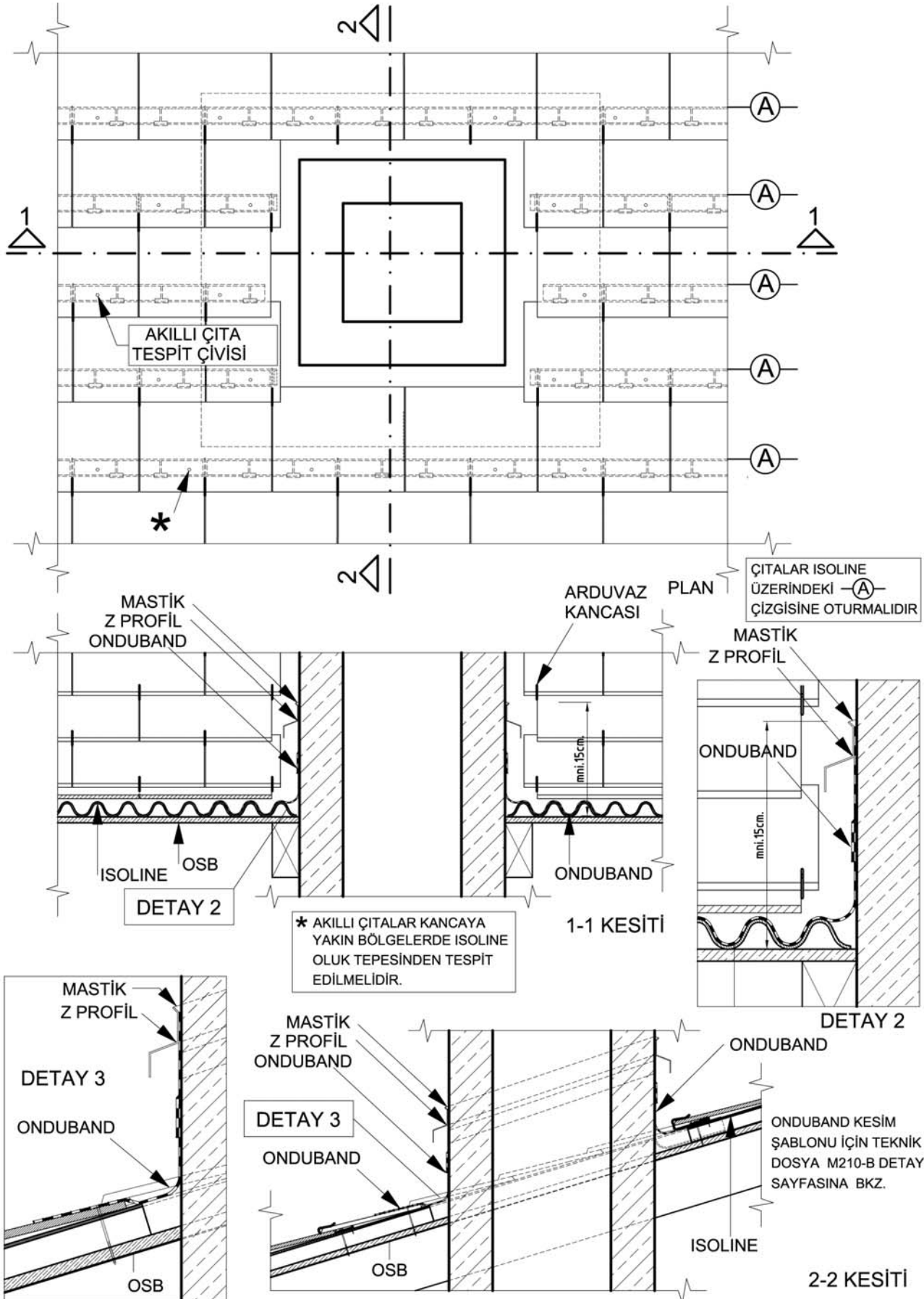

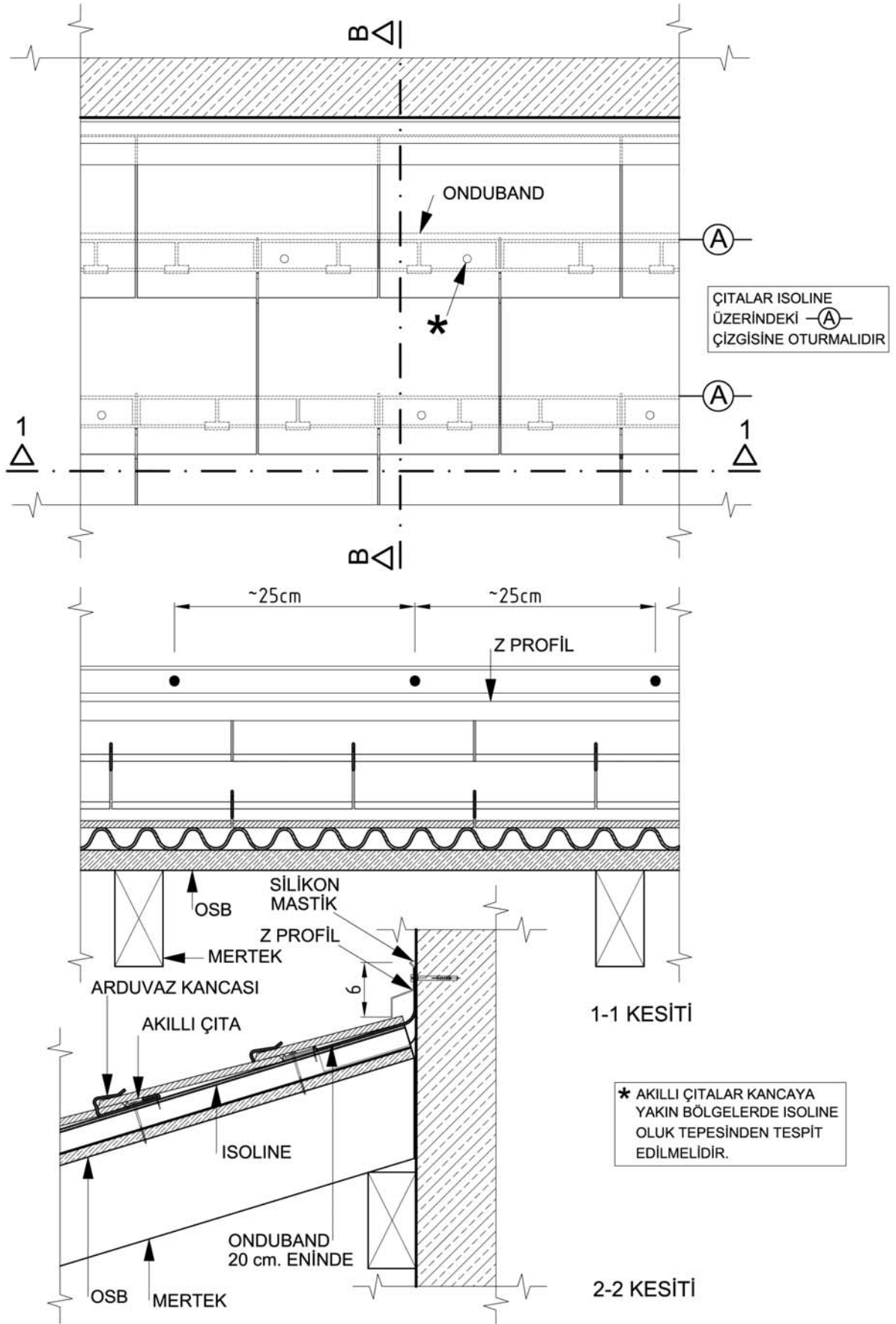

- 1 ONDUSOLAR PANEL
- 2 ALÜMİNYUM RAY 30 x 40 mm (*)
- 3 RAY BAĞLANTI ELEMANI (*)
- 4 ALÜMİNYUM PANEL TUTUCU (*)
- 5 ALÜMİNYUM PANEL TAŞIYICI (*)
- 6 ISOLINE UYUMLU BAĞLANTI - OMEGA 1
- 7 ISOLINE KİREMİT ALTI LEVHASI
- 8 OSB (d: 1,1cm)
- 9 KİREMİT SAN MARCO
- 10 40x40x2mm.KUTU PROFİL

- 11 40x80x2mm KUTU PROFİL - MP 80
- 12 DEMİR FLANŞ (15X20 cm) (*)
- 13 ÖZEL PROFİLLİ SOMUN
- 14 CİVATA M6 X 80
- 15 CİVATA M6 X 20
- 16 1.5/3.0 ÇİTA
- 17 Z PROFİL

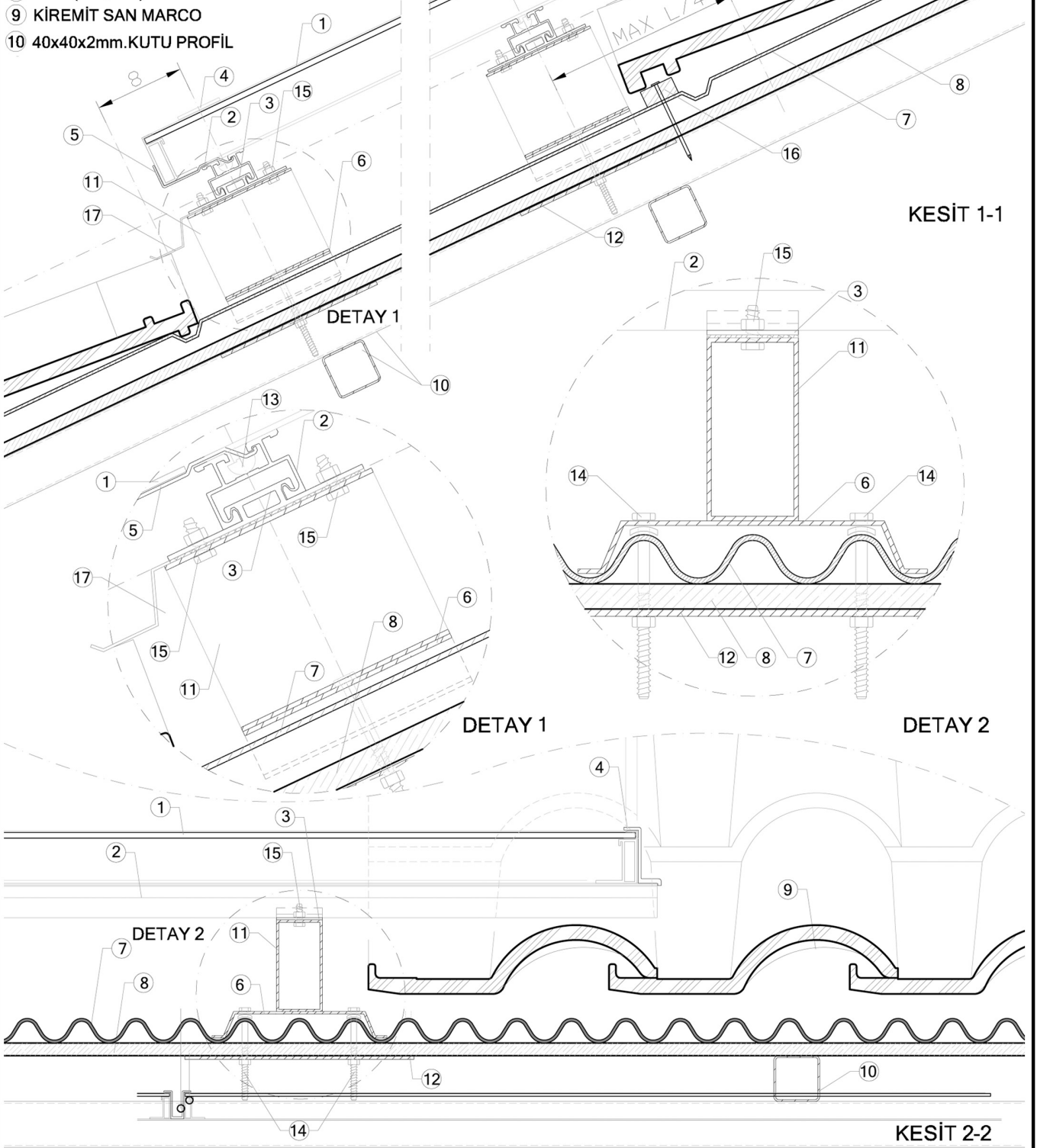

KESİT 1-1

DETAY 1

DETAY 2

KESİT 2-2

* Broşürde gösterilen detaylar OSB üzerine yapılacak uygulamaları içermektedir. Betonarme döşeme, çelik aşıklar, mertek gibi alt yapılarda bu prensipler dikkate alınarak rijit bağlantılar yapılmalıdır.